



# TPL 121250

## 12V 125Ah

TPL121250 is a general purpose battery up to 12 years expected life under normal float charge. As with all CSB batteries, all are rechargeable, highly efficient, leak proof and maintenance free.



### Specification

Nominal Voltage(V)	12
Capacity $25^{\circ}\text{C}$ (77°F)	125Ah @ 8hr-rate to 1.75V per cell
Dimensions (mm)	Height : 321.3 mm(12.65 inch)
	Length : 557 mm(21.92 inch)
	Width : 124.8 mm(4.91 inch)
Weight	Approx. 47kg(103.62 lbs)
Internal Resistance. Approx (mΩ)	Approx. 4.1mΩ
FlameRetardantContainer/ Cover UL - Laboratories Rating	PPE(UL 94-V0/File E161759)/L.O.I higher than 28 .
Float Charging $25^{\circ}\text{C}$ (77°F)	2.275±0.025V/cell Temperature coefficient -3.3mV/°C (1.8mV/°F)
Maximum Discharge Current in 5 seconds	800 A
Maximum Charge Current(C/5)	37.5 A
Service Temperature Range	Discharge: $-20^{\circ}\text{C}\sim 50^{\circ}\text{C}$ (-4°F~122°F)
	Charge: $-20^{\circ}\text{C}\sim 50^{\circ}\text{C}$ (-4°F~122°F)
	Storage: $-20^{\circ}\text{C}\sim 40^{\circ}\text{C}$ (-4°F~104°F)
Terminal Type	I2-Thread lead alloy recessed terminal to accept M6 bolt
Terminal Hardware Initial Torque	110-in-lbs.(12.4 N-m)



CSB-manufactured batteries are UL-recognized components under UL924 and UL1989. CSB is also certified by ISO 9001 and ISO 14001.

### Dimensions

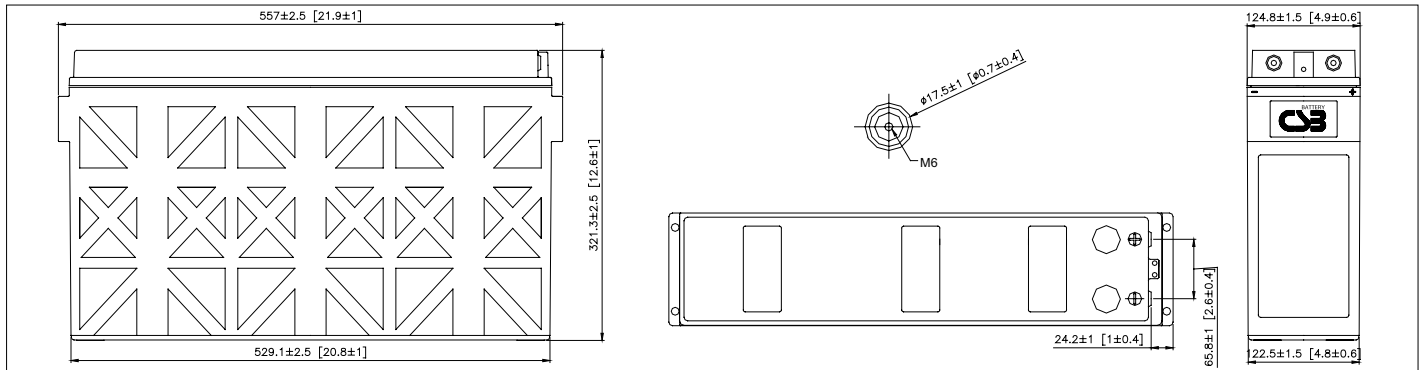

### TPL121250

#### Constant Current Discharge Characteristics Unit: Amperes (25 °C, 77 °F)

F.V/Time	15MIN	30MIN	1HR	2HR	3HR	4HR	5HR	6HR	7HR	8HR	10HR	20HR
1.67V	232	147	86.3	50.2	37.0	29.8	24.7	21.1	18.4	16.3	13.3	6.95
1.70V	220	142	84.4	49.1	36.6	29.4	24.4	20.8	18.1	15.9	13.1	6.88
1.75V	199	132	81.2	47.2	35.2	28.5	23.4	20.0	17.5	15.6	12.8	6.72
1.80V	176	121	76.7	45.1	33.8	27.2	22.7	19.5	17.0	15.1	12.5	6.56
1.83V	162	115	73.1	43.8	32.7	26.4	22.0	19.0	16.5	14.6	12.0	6.41
1.85V	153	110	70.4	42.8	31.9	25.5	21.5	18.5	16.2	14.4	11.9	6.25
1.90V	131	98.2	64.3	40.1	29.5	23.4	19.5	16.6	14.7	13.1	10.9	5.78

#### Constant Power Discharge Characteristics Unit: Watts (25 °C, 77 °F)

F.V/Time	15MIN	30MIN	1HR	2HR	3HR	4HR	5HR	6HR	7HR	8HR	10HR	20HR
1.67V	2461	1590	946	557	414	335	279	238	208	184	150	78.9
1.70V	2344	1542	936	556	413	333	277	237	207	182	149	78.7
1.75V	2138	1456	910	555	407	328	270	231	202	180	148	77.9
1.80V	1927	1364	876	549	400	317	265	228	198	176	145	77.0
1.83V	1797	1304	844	538	389	310	259	224	194	172	142	75.8
1.85V	1705	1255	822	529	382	306	254	219	192	170	141	74.3
1.90V	1510	1142	757	477	353	281	234	200	176	158	131	69.6

• All mentioned values are average values.

### Trickle (or Float) Service Life

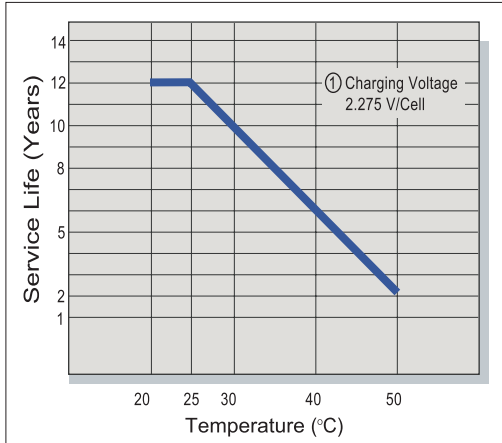

### Capacity Retention Characteristic

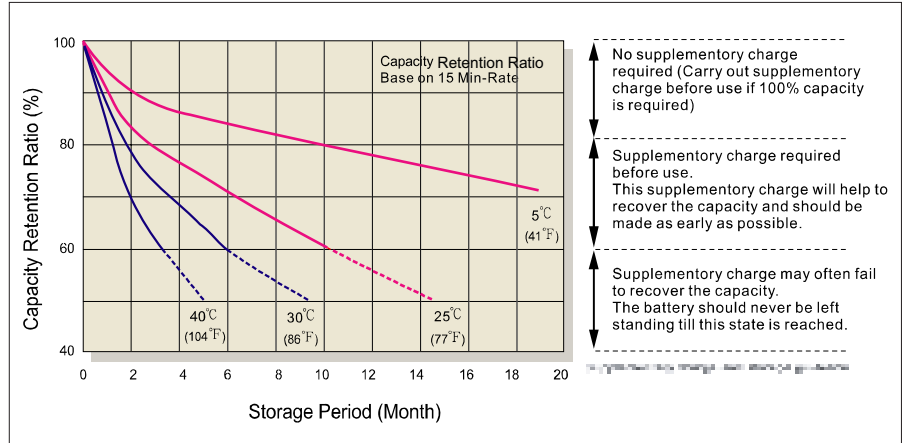

### Battery Voltage and Charge Time for Standby Use

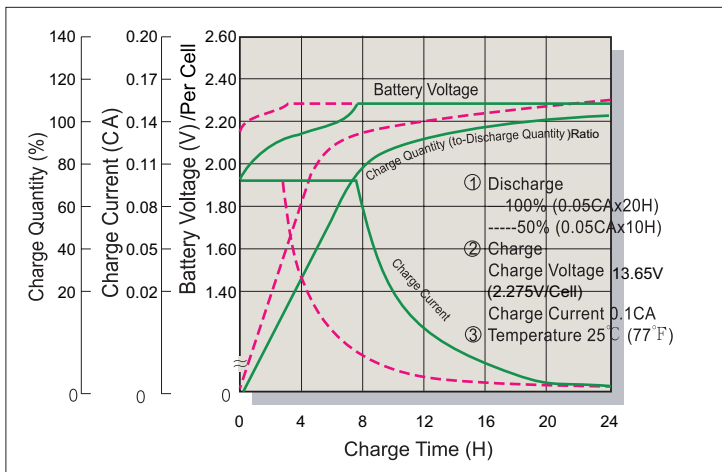

### Cycle Service Life

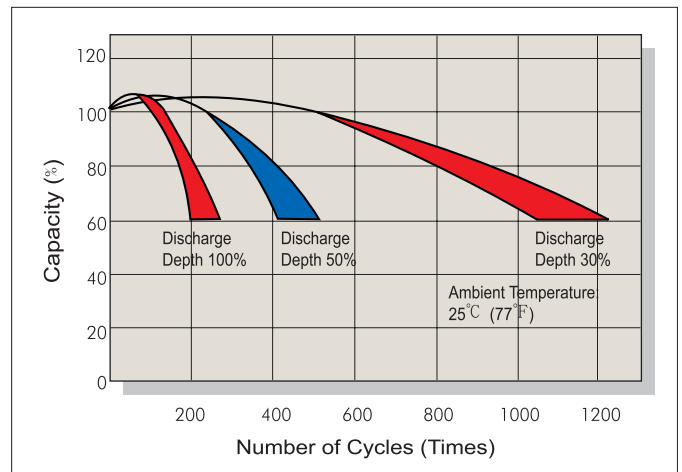

### Battery Voltage and Charge Time for Cycle Use

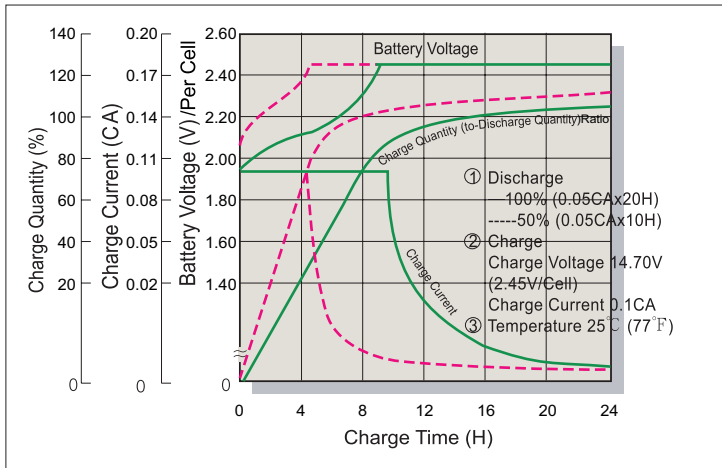

### Terminal Voltage (V) and Discharge Time

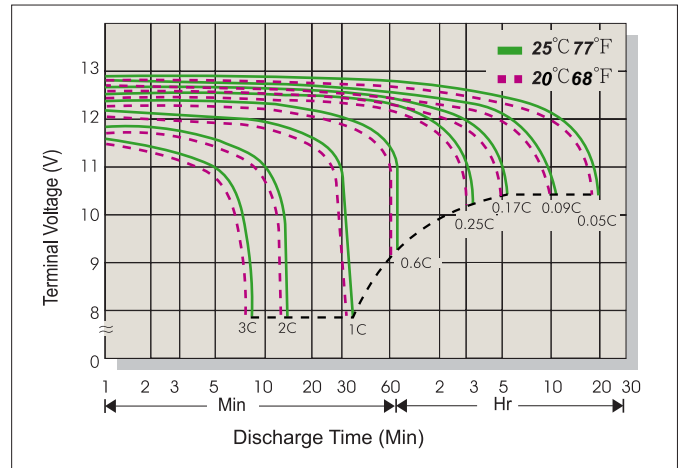

### Charging Procedures

Application	Charge Voltage(V/Cell)			Max. Charge Current
	Temperature	Set Point	Allowable Range	
Cycle Use	25°C (77°F)	2.45	2.40~2.50	0.3C
Standby	25°C (77°F)	2.275	2.25~2.30	

### Discharge Current VS. Discharge Voltage

Final Discharge Voltage V/Cell	1.75	1.70	1.60	1.30
Discharge Current(A)	0.2C>(A)	0.2C<(A)<0.5C	0.5C<(A)<1.0C	(A)>1.0C

Sales Office URL: [WWW.CSB-BATTERY.COM](http://WWW.CSB-BATTERY.COM)

**CSB BATTERY CO., LTD.**  
TAIWAN OFFICE  
Tel: +886-2-2555-5600  
Fax: +886-2-2555-3300  
E-mail: [service@csb-battery.com.tw](mailto:service@csb-battery.com.tw)

**CSB BATTERY LOGISTICS (SHANGHAI) CO., LTD.**  
SHANGHAI OFFICE  
Tel: +86-21-5046-1622, 5046-0833  
Fax: +86-21-5064-3314

**CSB BATTERY TECHNOLOGIES, INC**  
USA OFFICE  
Tel: +1-817-244-7777/1-8003 CSBUSA(272872)  
Fax: +1-817-244-4445  
E-mail: [csb@csb-battery.com](mailto:csb@csb-battery.com)

**CSB BATTERY LOGISTICS (SHANGHAI) CO., LTD.**  
BEIJING OFFICE  
Tel: +86-10-6597-8060, 6597-8070  
Fax: +86-10-6597-8050  
E-mail: [chinasls@csb-battery.com](mailto:chinasls@csb-battery.com)

**CSB BATTERY OF NETHERLANDS B.V**  
NETHERLANDS OFFICE  
Tel: +31(0) 180 418 140  
Fax: +31(0) 180 418 327  
E-mail: [eurosales@csb-battery.com](mailto:eurosales@csb-battery.com)

**CSB BATTERY LOGISTICS (SHANGHAI) CO., LTD.**  
SHENZHEN OFFICE  
Tel: +86-755-2694-2788/2606/2706  
Fax: +86-755-2694-2748  
E-mail: [she@csb-battery.com](mailto:she@csb-battery.com)